

**NO. 5 CATCH BASIN MANHOLE FRAME AND COVER WITH SIDE INLET**

TYPE F-36A NORWOOD FOUNDRY  
TYPE TF-36A BP TROJAN FOUNDRY

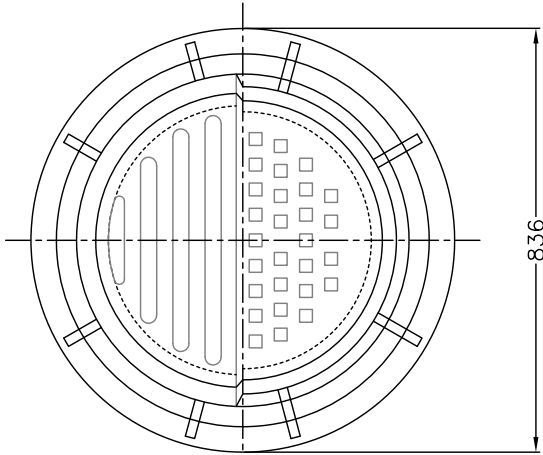

NOTE :  
FOR ROLLED CURB USE F-35A.

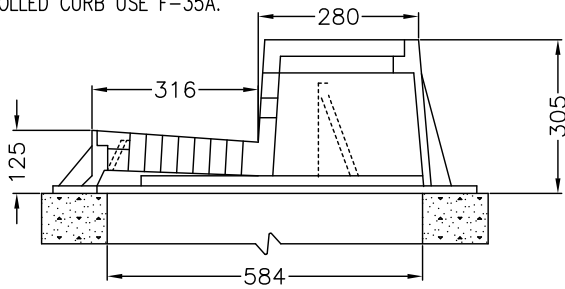

**NO. 7 FLOATING MANHOLE FRAME AND COVER TO BE USED IN ASPHALT ROADWAY SURFACES**

TYPE NF-80 NORWOOD FOUNDRY  
TYPE TF-80 TROJAN FOUNDRY

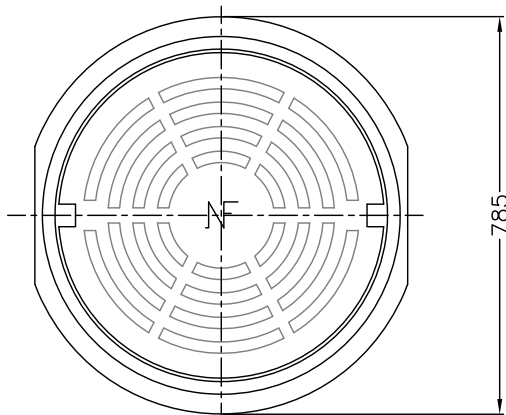

**NOTES:**

1. ALL DIMENSIONS IN MILLIMETRES UNLESS NOTED OTHERWISE
2. ALL COVERS TO BE ENGRAVED WITH "CITY OF WHITEHORSE" AND EITHER "STORM SEWER" OR "SANITARY SEWER"

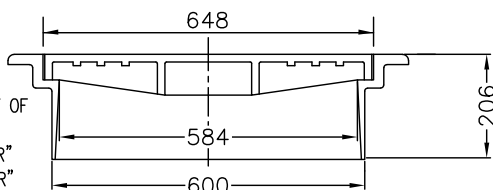

**NO. 6 STANDARD MANHOLE FRAME & COVER TO BE USED IN NON-ASPALT ROADWAY SURFACES**

TYPE F-39 NORWOOD FOUNDRY  
TYPE TF-39 TROJAN FOUNDRY

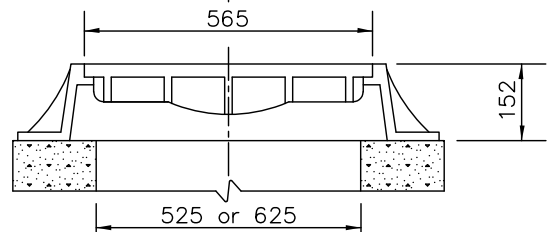
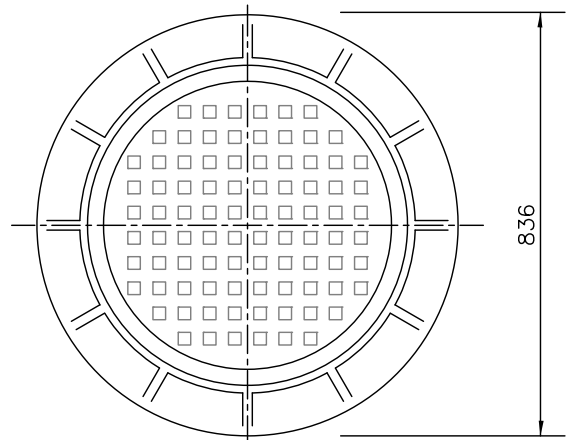

**NO. 8 CATCH BASIN WITH HIGH CAPACITY SIDE INLET FOR ROLLED CURB & GUTTER (DOUBLE AND SINGLE OPTIONS)**

TYPE SK-7(SINGLE) & DK-7(DOUBLE) NORWOOD FOUNDRY  
TYPE T-K7 TROJAN FOUNDRY (SINGLE AND DOUBLE OPTIONS)

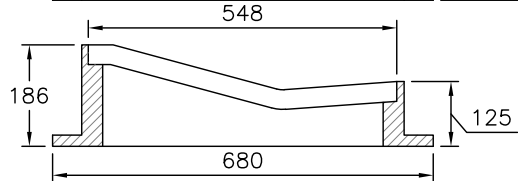
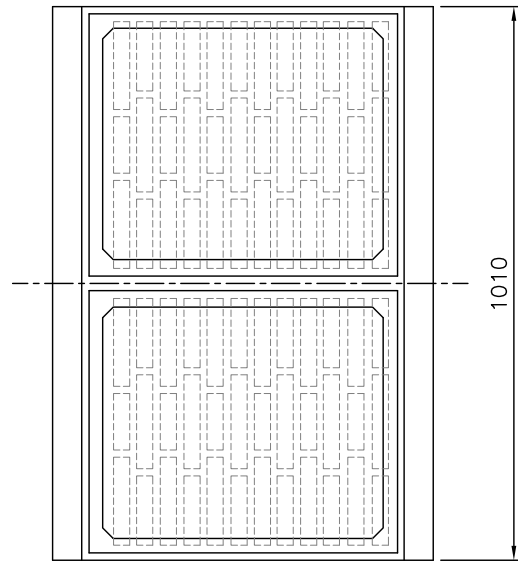

**STANDARD FRAMES AND COVERS  
FOR MANHOLES AND CATCH BASINS**

DATE: JANUARY 2020

STD DWG

A3.1